

Montering - Mounting - Montage

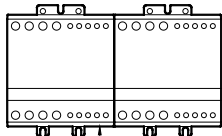

80 mm min.

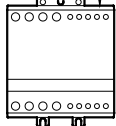

30 mm min.

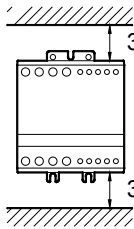

30 mm min.

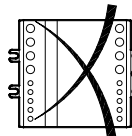

DK: Hvis enheden er monteret vandret, skal driftsstrømmen reduceres med 50%
Køleplade skal holdes ren.
Luftstrømmen må ikke blokeres

UK: If the unit is mounted horizontally the current must be derated by 50%
Keep heatsink clean. Airflow must not be blocked

DE: Falls Einheit horizontal montiert wird, muss der Strom um 50% reduziert werden.
Kühlflächen freihalten. Luftstrom muss ungehindert fließen

Dimensioner - Dimensions - Dimensionen

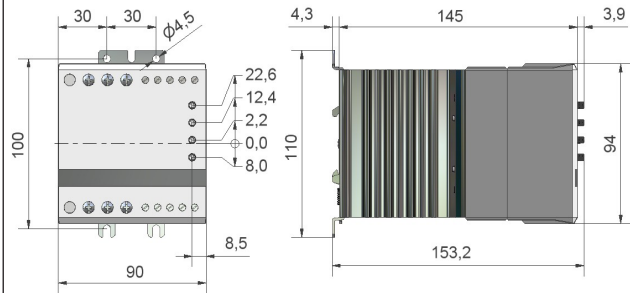
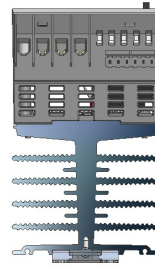

Forbindelse - Wiring - Verdrahtung

75°C Wire / Kabel	mm ²	mm ²
		1 x 6 - 10
	2 x 6	2 x 0.5 - 0.75
	1 x 6 - 10	1 x 0.5 - 1.5
	2 x 6	2 x 0.5 - 1.5
	1 x 6 - 10	1 x 0.5 - 1.5
	2 x 6	2 x 0.5 - 1.5
	Pozidrive 2 1.2 Nm max.	
	6mm 1.2 Nm max	3 mm 0.5 Nm max.

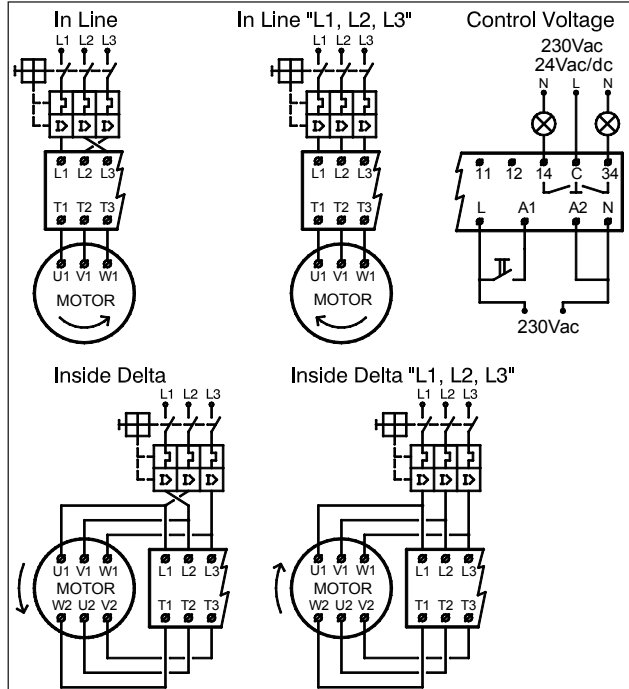

- **Vigtigt** (Overhold max skruedrejningsmomenter)
- **Important:** (Observe the maximum screw torque limits)
- **Wichtig:** (Max. Drehmoment beachten)

DK: Hvis beskyttet med sikringer, se specifikationer i datablad.
UK: If protection with fuses, see recommendation in data-sheet.
DE: Falls Sicherungen verwendet werden, Empfehlungen im Datenblatt beachten.
This product has been designed for class A equipment. Use of the product in domestic environments may cause radio interference, in which case the user may be required to employ additional mitigation methods.
Do not connect power factor correction capacitors.

Funktions / Functional / Funktionsdiagram

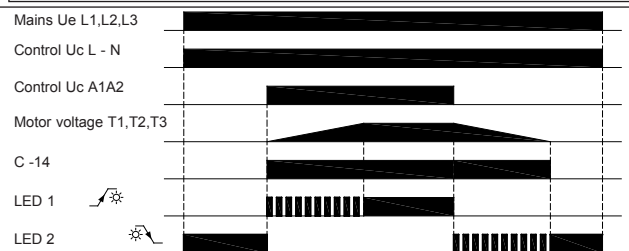

Max omgivelsestemperatur: 40°C./ 100% belastning - 50°C./ 80% belastning - 60°C./ 70% belastning
Maximum surrounding temperature: 40°C./ 100% load duty-cycle - 50°C./ 80% load duty-cycle - 60°C./ 70% load duty-cycle
Maximale Umgebungstemperatur: 40°C./ 100% last - 50°C./ 80% last - 60°C./ 70% last
DK: Se specifikationer i datablad UK: See recommendation in datasheet DE: Empfehlungen im Datenblatt beachten

Indstilling - Settings - Einstellungen

		<ul style="list-style-type: none"> In Line / Anschluss Dreieck In Line / phase sequence / Phasenfolge (L1,L2,L3)
		<ul style="list-style-type: none"> Inside Delta / Anschluss Wurzel 3 Inside Delta / Anschluss Wurzel 3 (L1,L2,L3)
		<ul style="list-style-type: none"> Start Rampe tid 0.5 - 30 sek Ramp-up time 0.5 - 30 sec Anlaufzeit 0,5 bis 30 sec
		<ul style="list-style-type: none"> Rampe - ned 0.5 - 60 sek Ramp-down time 0.5 - 60 sec Ablaufzeit 0.5 bis 60 sec
		<ul style="list-style-type: none"> Start moment 0 - 85% Initial torque 0 - 85% Anlauf Drehmoment 0 - 85%
		Kick start 200 msec

Motor Voltage

100%

0

Tid
Zeit

Bemærkninger - Remarks - Bemerkungen

DK	UK	DE
<ul style="list-style-type: none"> - Anvend 2 mm x 0.5 mm skruetrækker - Vær forsigtig ikke at indstille drejekontakterne imellem klik. - Motor Controlleren aflæser tid og moment justeringen i stop tilstand. - Gentagne start forsøg kan resultere i at motoroverbelastnings relæet aktiveres 	<ul style="list-style-type: none"> - Use 2 mm x 0.5 mm screwdriver - Make sure that the switches click into position, otherwise time and torque settings will not be correct. - The motor controller will read time and torque settings in the off state - Repeated starts may trip the motor protection relay 	<ul style="list-style-type: none"> -Schraubenzieher 2 mm x 0.5 mm verwenden - Schalter müssen einrasten, um korrekte Funktion zu gewährleisten. - Eingestellte Werte werden im ausgeschalteten Zustand abgelesen. - Mehrfach Starts kann Motorschutzrelais auslösen

Start moment indstilling - Initial torque setting - Einstellung der Startleistung

DK	UK	DE
<ol style="list-style-type: none"> 1) Indstil Ramp-up til max. 2) Indstil <Ramp-down til min. 3) Indstil Initial Torque til min. 4) Påtryk signalspændingen i et par sekunder, hvis ikke motor akslen roterer øjeblikkelig efter start, juster Initial Torque en deling op. Gentag indtil motor akslen roterer øjeblikkelig efter start. 	<ol style="list-style-type: none"> 1) Set Ramp-up switch to maximum 2) Set Ramp-down switch to minimum 3) Set Initial Torque switch to minimum 4) Apply controlvoltage for a few seconds. If the load does not rotate immediately increase the Initial Torque one step and try again. Repeat until the load starts to rotate immediately on start up. 	<ol style="list-style-type: none"> 1) Ramp-up Schalter auf max. stellen 2) Ramp-down schalter auf min. stellen 3) Initial Torque Schalter auf min. stellen 4) Steuerspannung einige Sekunden betätigen. Falls Motor nicht sofort anläuft, Initial Torque schrittweise erhöhen bis Motor anläuft
<p>Hvis Initial-Torque justeringen ikke er tilstrækkelig til at starte motoren, er det nødvendigt at anvende Kick-start</p> <ol style="list-style-type: none"> 1) Indstil Ramp-up til max. 2) Indstil Ramp-down til min. 3) Indstil Initial Torque til min. (Kick-Start) 4) Påtryk signalspændingen i et par sekunder, hvis belastningen stopper, juster Initial Torque en deling op. Gentag indtil motor akslen forsætter med at rotere efter start. 	<p>If the max. InitialTorque settings is not sufficient to start the motor it is necessary to use Kick-start.</p> <ol style="list-style-type: none"> 1) Set Ramp-up switch to max. 2) Set Ramp-down switch to min. 3) Set Initial Torque switch to min. kick-start 4) Apply controlvoltage for a few seconds.If the load stops right after kick-start increase the Initial Torque one step. Repeat until the load starts to rotate after the kick. 	<p>Falls Initial-torque max. Einstellung nicht ausreichend um den Motor zu starten, muss Kick-start verwendet werden.</p> <ol style="list-style-type: none"> 1) Ramp-up auf max. stellen 2) Ramp-down auf min. stellen 3) Initial Torque auf min. stellen. Kick-Start 4) Steuerspannung einige Sekunden betätigen. Falls der Motor sofort wieder stoppt, Initial Torque schrittweise erhöhen, is der Motor sofort nach dem Kick anläuft.

Rampe-op/ned indstilling - Ramp-up/down settings - Einstellung der Start/Stopzeit

DK	UK	DE
<ol style="list-style-type: none"> 1) Indstil Ramp-up til max og motoren starter. 2) Gradvis nedsæt Ramp-up tiden indtil motoren starter som ønsket <ol style="list-style-type: none"> 1a) Indstil Ramp-down tiden til max og afbryd signalspændingen. 2a) Gradvis nedsæt Ramp-down tiden indtil motoren og belastning stopper som ønsket. 3a) Juster Ramp-down tiden et trin op. 	<ol style="list-style-type: none"> 1) Set Ramp-up switch to maximum and the motor starts. 2) Decrease the Ramp-up time until desired start is achieved. 3) Increase Ramp-up one step. <ol style="list-style-type: none"> 1a) Set Ramp-down switch to max and switch off the controlvoltage. 2a) Decrease the Ramp-down time until mechanical surge is observed. 3a) Increase Ramp-down time one step. 	<ol style="list-style-type: none"> 1) Ramp-up Schalter auf max. stellen. 2) Ramp-up Zeit solange verküzen, bis Überbelastung beobachtet wird. 3) Ramp-up Zeit um einem Schritt erhöhen. <ol style="list-style-type: none"> 1a) Ramp-down auf max. stellen und Steuersignal ausschalten. 2a) Ramp-down Zeit solange verküzen, bis Überbelastung beobachtet wird. 3a) Ramp-down Zeit um einem Schritt erhöhen.

Funktions fejl / Functional fault / Betriebsstörungen

LED 1 + 2 Fejl - failure - Fehler C-34		
LED 1 + 2 Kontrolspænding fejl - control voltage failure Steuerspannung Fehler (2,5 Hz)		
LED 1 + 2 Netspændingsfejl - Line voltage failure Betriebsspannung fehler L1/L2/L3 (5 Hz)		